

# HALO™



TOUCH

FINGERPRINT SMART LOCK



## Installation and Reference Guide

# Welcome to the Kwikset family!

This guide will get you up and running with your new **Halo Touch Fingerprint Smart Lock**.

If you have any issues, please visit our support center: [kwikset.com/halo-touch](https://www.kwikset.com/halo-touch) or call us at 1-800-327-5625.

# Getting started

For an interactive version of this installation guide, please download the **Kwikset app**:



[kwikset.com/app](https://kwikset.com/app)





# Table of contents

Parts in the box .....	4
Required tools .....	5
Installation.....	7
Download the app.....	17
Reference guide .....	19

# Parts in the box

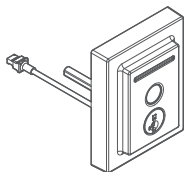

Exterior assembly

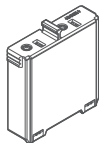

Battery pack

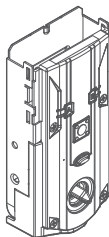

Interior assembly

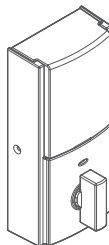

Interior cover

## Step 1

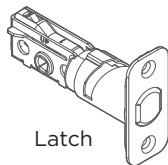

Latch

### 03809

*actual  
size*

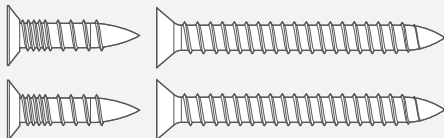

## Step 2



Strike

### 46780

*actual  
size*

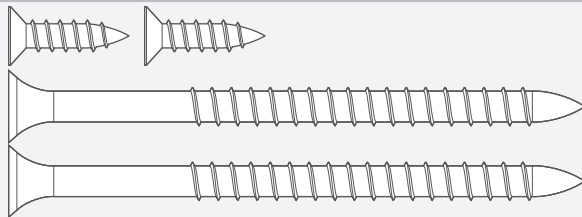

Step **3**

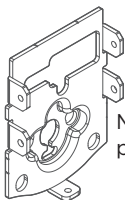

Mounting plate



Keys

**64844**

*actual size*

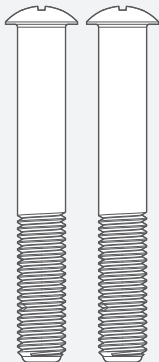

Step **4**

**49191**

*actual size*

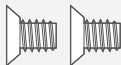

Step **5**



Batteries



SmartKey™  
tool

**68611**

*actual size*



**64109**

*actual size*

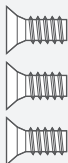

## Required tools



Phillips head  
screwdriver

No electric drills

# Installation



# ! Remove your existing deadbolt

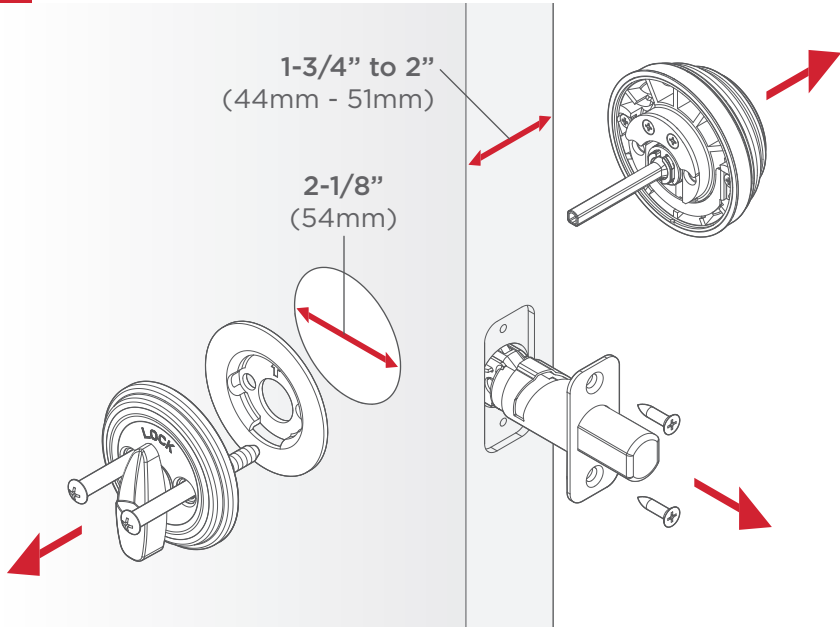

 If drilling a new door, use the supplied template and instructions available at: [kwikset.com/doorprep](http://kwikset.com/doorprep)

# 1 Install the latch

A Extend the latch bolt.

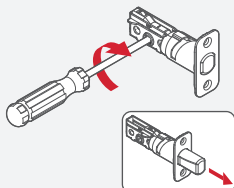

B UP is on top.

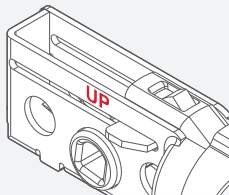

C If the D-shaped hole is not centered in the door hole, rotate the latch face to extend the latch.

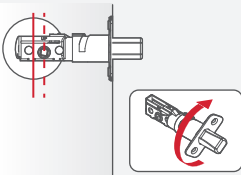

⚠ If your door requires a drive-in latch, please contact Kwikset at 1-800-327-5625.

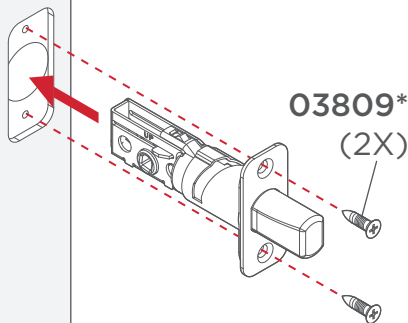

\*Use the longer screws if the holes are worn out.

You will have two extra screws.

## 2 Install the strike

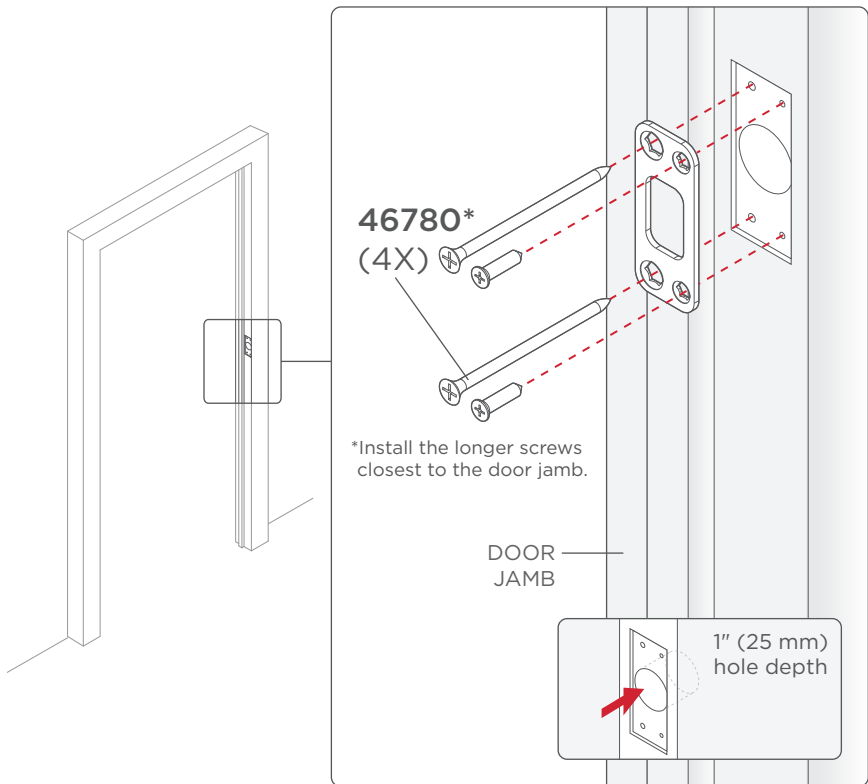

### 3 Install the exterior assembly

[OUTSIDE]

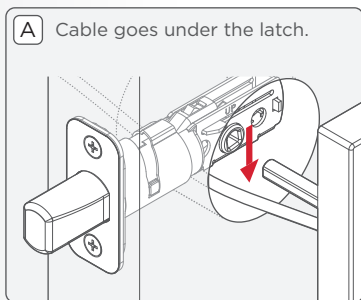
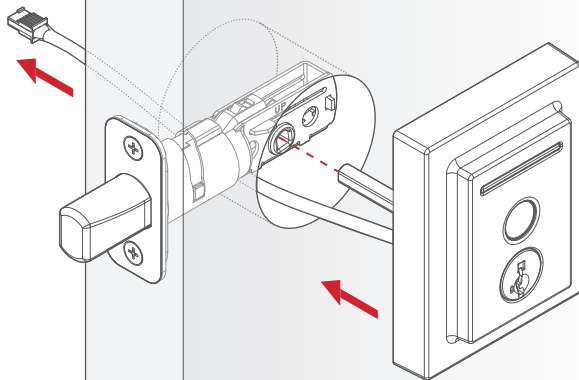

[INSIDE]

Keep parallel to  
the door edge

Tighten the screws evenly.  
**DO NOT** over-tighten.



**64844**  
(2X)

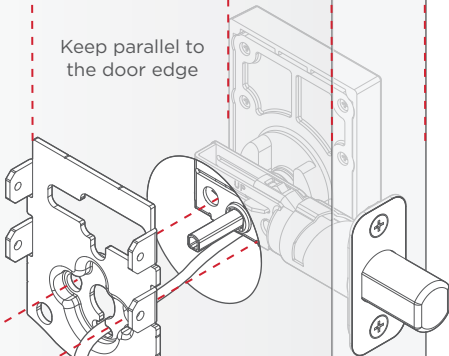

- B** Route the cable through the center hole, then push into the bottom hole.

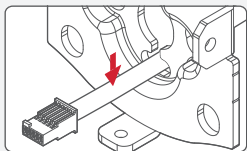

- C** Insert the key and test the latch. If the latch does not extend or retract smoothly, adjust the screws.

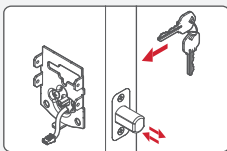

## 4 Install the interior assembly

- A** Make sure the turnpiece shaft is pointing up as shown below.

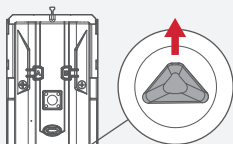

Incorrect:



- B** If the turnpiece shaft is not pointing up, put the cover back on and rotate the turnpiece until you hear a click.

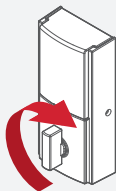

Remove the interior cover from the interior assembly.

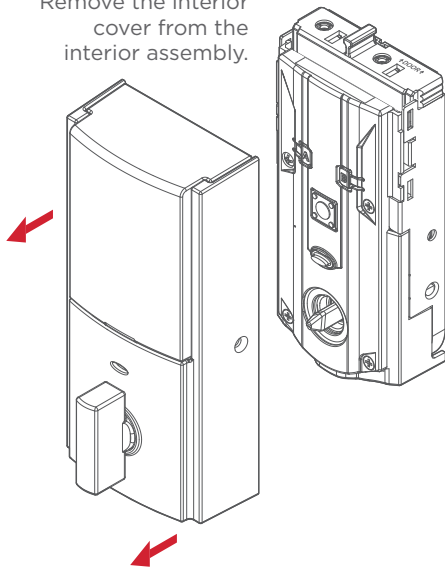

Secure the interior assembly onto the mounting plate.

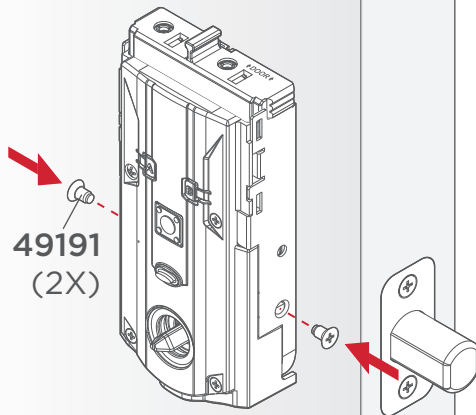

[INSIDE]

- C** Connect the cable. Ensure a tight cable connection.

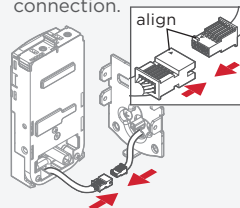

- D** Lay cable flat inside the bottom of the interior housing.

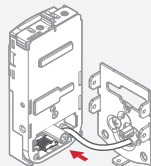

- E** Ensure the spindle fully engages with the turnpiece shaft.

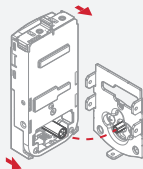

## 5 Perform the door handing process

Install 4 AA batteries into the battery pack.

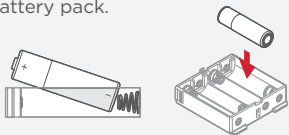

The latch will retract and extend to learn the orientation of the door. Then the status LED will indicate success or failure.

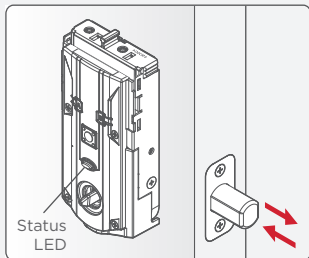

**GREEN:** Successful. Proceed to the next step.

**RED:** Unsuccessful. Make sure the lock interior and batteries are correctly installed. Perform step 5 again. If your second attempt is still unsuccessful, follow the [Manual Door Handing](#) instructions.

With the door open, install the battery pack to initiate auto-handing. **NOTE: Lock must be installed on the door before installing the battery.**

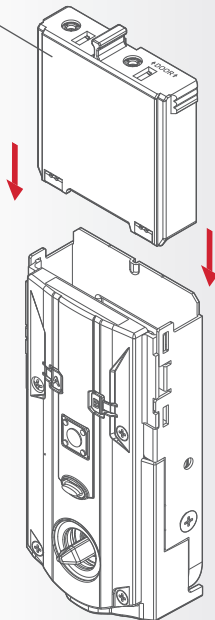

[INSIDE]

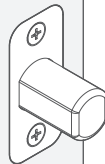



Secure the interior cover onto the interior assembly.

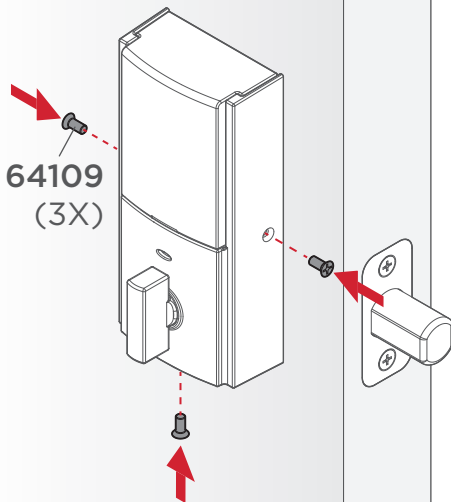

[INSIDE]

You may need to rotate the turnpiece to align with the turnpiece shaft.

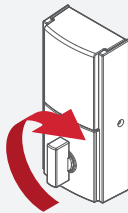

For additional security, you may choose to lock the window by installing the security screw.

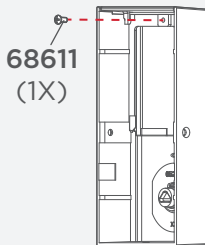

When the window is locked, you will need to remove the entire cover to access the battery pack and buttons.

Download the app  
& create an account

# Create your account

Follow the setup instructions in the **Kwikset app** to create your account:



[kwikset.com/app](https://kwikset.com/app)



The Kwikset app is needed to use this lock. If this lock was professionally installed (or installed by someone other than the homeowner), make sure this step is performed by the homeowner.

# Reference Guide

## Locking

To lock your door, place **any** finger on the fingerprint sensor. The light bar will display the following animations, beep once, and the door will lock.

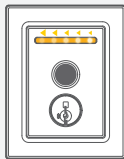
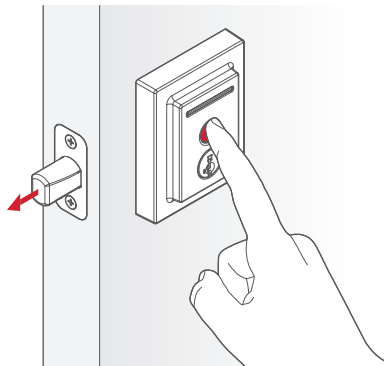

Orange sweep,  
moving toward  
door edge

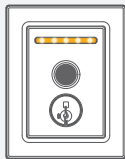

All LEDs  
orange for  
2 seconds

## Unlocking

To unlock your door, place your **enrolled** finger on the fingerprint sensor. The light bar will display the following animations, beep once, and the door will unlock.

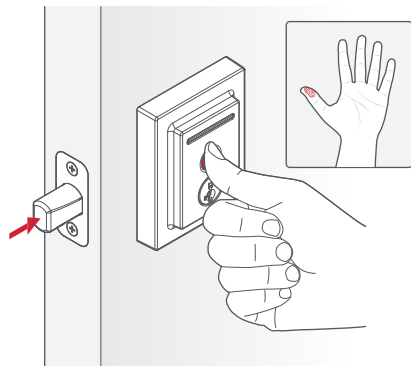

All LEDs  
blue during  
authentication



Green sweep,  
moving away  
from door edge.

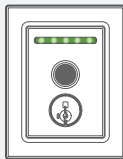

All LEDs  
green for  
2 seconds

## Enabling Amazon Alexa

Follow the setup instructions to enable Amazon Alexa:



[Amazon Alexa Guide](#)

## Enabling Google Assistant

Follow the setup instructions to enable Google Assistant:



[Google Assistant Guide](#)

## SmartKey Re-key

Re-key the lock to work with your existing key by following the [SmartKey Re-key instructions](#).

**NOTE:** If Auto-Lock is enabled, remove the battery pack before re-keying your lock.

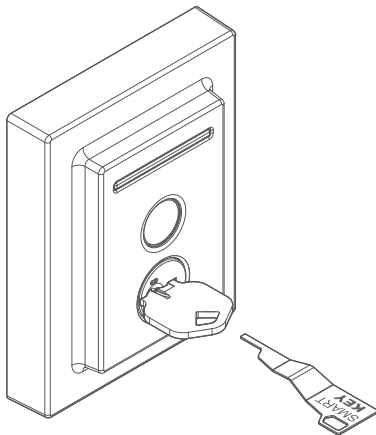

# Exterior LED Indicators

**Orange:**  
Locking

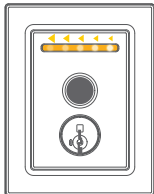

**Green:**  
Unlocking

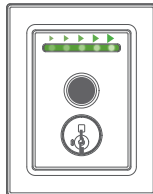

**Blue:**  
Authenticating fingerprint

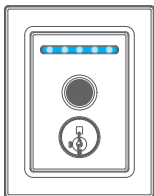

**Red:**  
Low battery or door jam

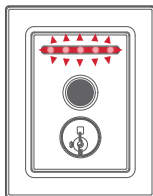



# Interior LED Indicators

## Green

**Solid:**

Action successful

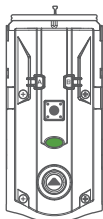

**Blinking:**

Unlocked

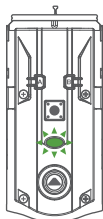

## Red

**Solid:**

Door handling  
unsuccessful

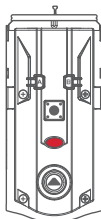

**Blinking:**

Low battery or  
action unsuccessful

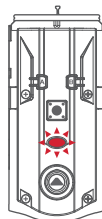

## Blue

**Solid:**

Bluetooth pairing  
successful

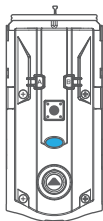

**Blinking:**

Bluetooth pairing  
mode

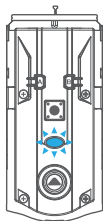

## Orange

**Solid:**

Entering network  
reset mode

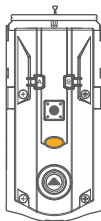

**Blinking:**

Locked or network/  
system mode

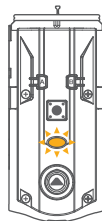

## Device Compatibility

Please see the  
**Device Compatibility**  
list to see if your device  
is compatible.



[Device Compatibility](#)

## Router Compatibility

Please see the  
**Router Compatibility**  
list to see if your router  
is compatible.



[Router Compatibility](#)

**NOTE:** Halo Touch implements a standard based Wi-Fi radio and should work with majority of the routers available in the market that are Wi-Fi certified.

# Manual Door Handing

If needed, the door handing process can be initiated manually. This is useful if the lock is being moved to a different door.

1. Remove battery pack.

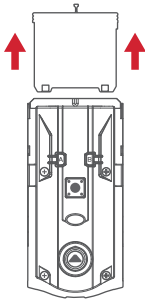

2. Press and HOLD the Program button while reinserting the battery pack. Release the Program button after 3 seconds. The status LED will flash red and green.

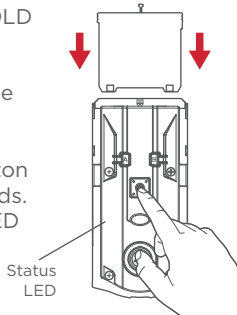

3. Press the Program button once more.

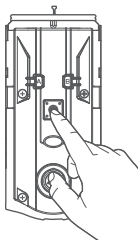

4. The latch bolt will extend and retract to learn the orientation of the door. The LED will flash green if handing is successful or red if handing is unsuccessful.

# Factory Reset

Factory Reset will:

- delete all Wi-Fi settings
- delete user associations
- reset all lock settings including handing
- delete access codes and event history from the lock. **Note: They will still appear in the app and cloud until the lock is deleted from the app.**

Factory reset should be used when:

- you want to change the lock owner
- you have lost your phone
- you are troubleshooting on a new installation

1. [Delete the lock](#) from the Kwikset app.

2. Remove the lock from the Bluetooth list on your device by tapping “Forget Device” in the Bluetooth settings.

Continue to the next page for additional steps.

3. Remove battery pack.

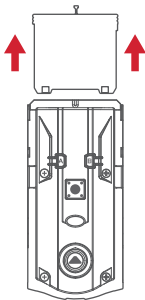

4. Press and HOLD the Program button while reinserting the battery pack.

Keep holding the button for 30 seconds or until the lock beeps and the status LED flashes red. Then release the Program button.

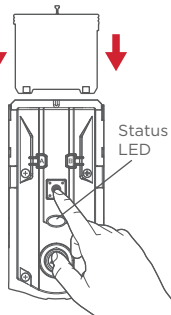

5. After the beeping stops, press and release the Program button once more. The LED will flash green and red, and the auto-handing process will begin.

**Note: It can take a few seconds for the handing to start.**

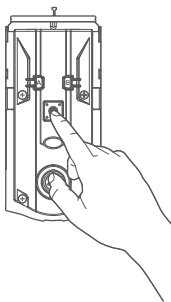

6. The latch will retract and extend to learn the orientation of the door. This confirms the Factory Reset has been completed.

The LED will flash green if auto-handing is successful or red if auto-handing is unsuccessful.

If the Factory Reset is not successful, perform the steps again until the LED flashes green and red.

# Halo Touch at a Glance

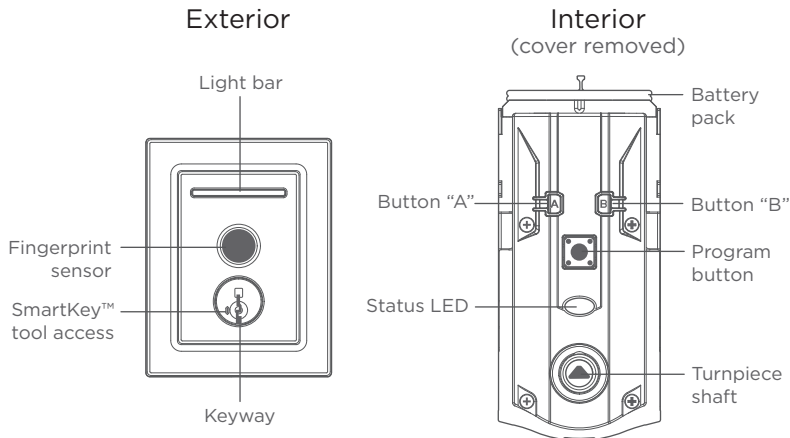

## Troubleshooting

If you have any issues, please visit our support center: [kwikset.com/halo-touch](http://kwikset.com/halo-touch) or call us at **1-800-327-5625**.



# Important Safeguards

1. Read all instructions in their entirety.
2. Familiarize yourself with all warning and caution statements.
3. Remind all family members of safety precautions.
4. Always have access to your lock's standard key.
5. If using the Auto-Lock features, make sure you have your smartphone or standard key with you to prevent locking yourself out.
6. Familiarize yourself with all light bar error notifications.
7. Replace low batteries immediately.
8. Dispose of used batteries according to local laws and regulations.

**⚠ WARNING:** This Manufacturer advises that no lock can provide complete security by itself. This lock may be defeated by forcible or technical means, or evaded by entry elsewhere on the property. No lock can substitute for caution, awareness of your environment, and common sense. Builder's hardware is available in multiple performance grades to suit the application. In order to enhance security and reduce risk, you should consult a qualified locksmith or other security professional.

---

## Regulatory Compliance

This product complies with standards established by the following regulatory bodies:

- Federal Communications Commission (FCC)
- Industry Canada

### FCC

This device complies with Part 15 of the FCC Rules. Operation is subject to the following two conditions: ( 1 ) this device may not cause harmful interference, and ( 2 ) this device must accept any interference received, including interference that may cause undesired operation.

This equipment has been tested and found to comply with the limits for a Class B digital device, pursuant to Part 15 of the FCC Rules. These limits are designed to provide reasonable protection against harmful interference in a residential installation.

This equipment generates, uses, and can radiate radio frequency energy and, if not installed and used in accordance with the instructions, may cause harmful interference to radio communications. However, there is no guarantee that interference will not occur in a particular installation. If this equipment does cause harmful interference to radio or television reception, which can be determined by turning the equipment off and on, the user is encouraged to try to correct the interference by one or more of the following measures:

- Reorient or relocate the receiving antenna.
- Increase the separation between the equipment and receiver.
- Connect the equipment into an outlet on a circuit different

from that to which the receiver is connected.

- Consult the dealer or an experienced radio/TV technician for help.

**IMPORTANT!** Changes or modifications not expressly approved by the manufacturer could void the user's authority to operate the equipment.

### Industry Canada

This device contains licence-exempt transmitter(s)/ receiver(s) that comply with Innovation, Science and Economic Development Canada's licence-exempt RSS(s). Operation is subject to the following two conditions: ( 1 ) This device may not cause interference, and ( 2 ) This device must accept any interference, including interference that may cause undesired operation of the device.